

Electric Vehicle AC Charger Instructions

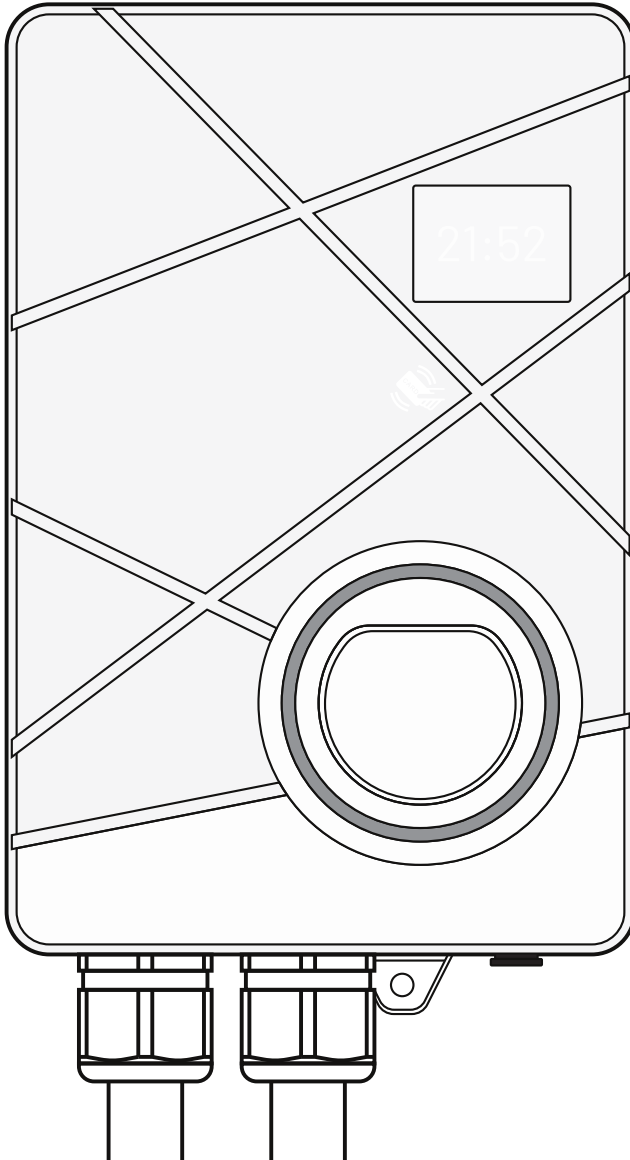

CONTENTS

1. Important Safety Instructions.....	01
2. Product Introductions.....	02
3. Accessories.....	05
4. Tool for Mounting	06
5. Plan The Mounting.....	06
6. Wire the Circuit	09
7. Operate the Device	11
8. APP Operation Guide.....	15
9. Error and Warning Messages.....	20
10. Warranty and Maintenance.....	20

⚠ WARNING & CAUTION

1. Important Safety Instructions

1.1 Overall Warnings & Cautions

- ⚠ WARNING:**
To avoid fire, injury or death, carefully read and follow the instructions during installation, operation and maintenance.
DONOT put fingers into the electric vehicle connector.
DONOT use this product if the flexible power cord or EV cable is frayed, insulation-broken, or any other signs of damage.
DONOT use this product if the enclosure or the EV connector is broken,cracked,open,or shows any other indication of damage.
DONOT remove cover or attempt to open the enclosure because of risk of electric shock.
- ⚠ WARNING:** This device should be supervised when used around children.
- ⚠ WARNING:** This device must be grounded.
- ⚠ WARNING:** To avoid a risk of fire or electric shock, do not use this device with an extension cord.

Circuit Breaker Options			
	1-phase	3-phase	
Output Amperage(A)	32A	16A	32A
Circuit Breaker Options (A)	40A	20A	40A

1.2 Installation Requirements

- ⚠ WARNING:**
Disconnect electrical power prior to installing the charging station.
- ⚠ WARNING:**
Be sure to preview the user manual and ensure local building and electrical codes are reviewed before installing the AC charger.
- ⚠ WARNING:**
The AC charger should be installed by a qualified technician according to the user manual and local safety regulations.
- ⓘ CAUTION:**
Use appropriate protection when connecting to the main power distribution cable.
- ⓘ CAUTION:**
Type A, B, C or D breaker with the rating current for table should be installed in the upstream AC distribution box.
- ⓘ CAUTION:**
The device shall be mounted at height between 600 mm and 1200 mm from ground.
- ⓘ CAUTION:**
Please keep the charger in a clean area with low humidity. Not recommended to be installed in coastal environments with high humidity or high dust.

1.3 Daily Maintenance

- ⚠ CAUTION:**
 Avoid moisture or water in the charger. If there is water or moisture ingress in the charger, it is necessary to immediately power off to avoid immediate danger, and notify the professionals to carry out maintenance before next use.
- ⚠ CAUTION:**
 Please use the charger properly. Do not hit or press hard on the enclosure. If it is damaged, please contact a professional technician.
- ⚠ CAUTION:**
 Avoid placing the charger near hot objects and at high temperature locations and away from dangerous substances such as flammable gases and corrosive materials.
- ⚠ CAUTION:**
 Do not put heavy objects on the charger to avoid danger.

2. Product Introductions

2.1 Basic Interface

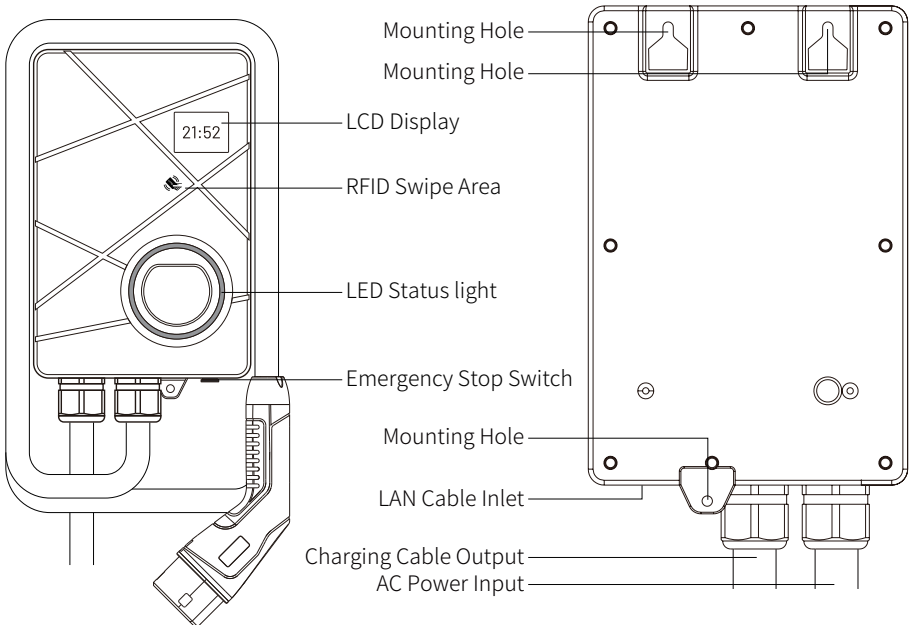

USER MANUAL

2.2 Basic Dimension

Enclosure

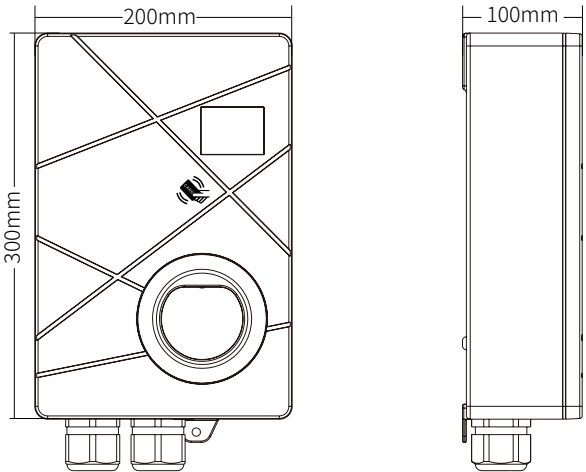

Wall-Mounted holes

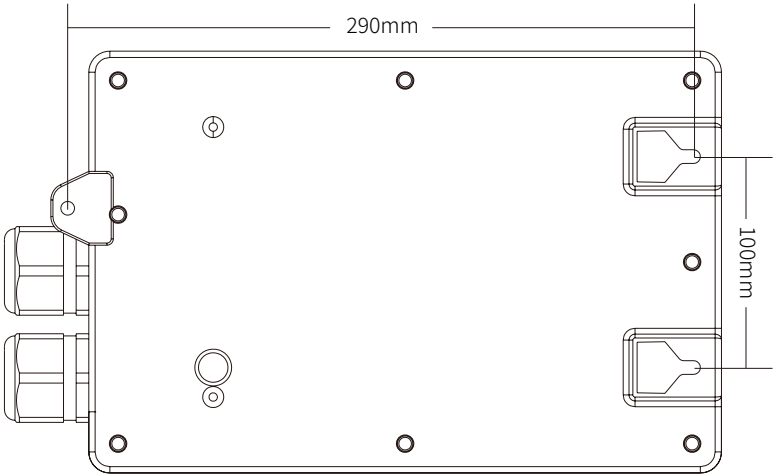

2.3 Specifications

TECHNICAL	
Model Number	BK
Rated Input Voltage	230Vac±10% 400Vac±10%
Rated Output Current	7kW/32A 11kW/16A;22kW/32A
Standard Compliance	IEC 61851-1,IEC 61851-21-2
Charging Connector	6 Meters Tethered IEC Type 2 Lead
Charging Mode	Mode 3
Electrical Protection	UVP, OVP,RCD (DC 6mA) ,SPD, Ground Fault Protection OCP, OTP, Control Pilot Fault Protection
FEATURES	
User Interface	LCD Display
Multi Cable Entry	Bottom Side
NETWORK	
Connectivity	LAN and Wi-Fi
ENVIRONMENT	
Operating Temperature	-30°C to 50°C
Operating Humidity	Up to RH 95% Non-condensing
Impact/ Ingress Protection Rating	ip54
PHYSICAL	
Housing Material	PC with Anti-UV Treatment
Dimension in mm	300*200*100(D*W*H)
Net Weight	≈5.2kg
OPTIONS	
Network	
Communication Protocol	OCPP1.6J
Electrical Protection	E-stop Button with Protection Cover
Data Connection	Back-end Service via OCPP / Home App
NFC Authentication	ISO/IEC 14443A/MIFARE(13.56 MH)
Pedestal	Single/Back-to-Back Mounted

USER MANUAL

3. Accessories

Check the box to ensure you these parts:

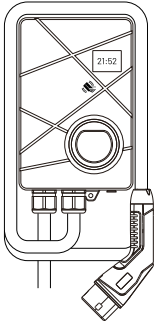

#1

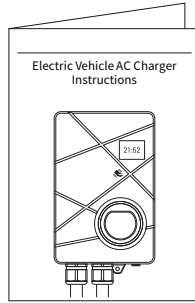

#2

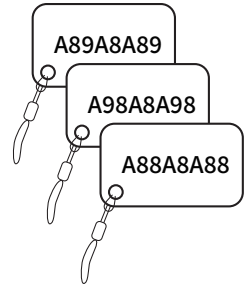

#3

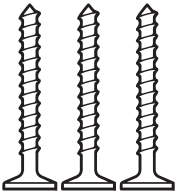

#4

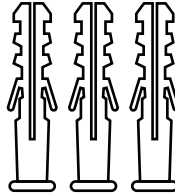

#5

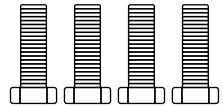

#6

NO.	Product Name	Quantity	Description
#1	AC Charger	1	With attached input power cable and output charging cable
#2	User Manual	1	PDF version available online
#3	RFID card	3	Used to swipe the card to boot the device
#4	Screws	3	For installing the AC Charger to the wall/structure
#5	Expansion Rubber Sleeve	3	For Lock Screw to the wall/structure
#6	Screws	3	For mounting the device cover

4. Tool for Mounting

Tools required before installing the Wall-Mounted charger, gather the following tools:

1. Wire stripper
2. Adjustable Wrench
3. Voltmeter or digital multi-meter (for measuring AC voltage at the installation site)
4. Level
5. Pencil or marker
6. Drill
7. Phillips screwdriver

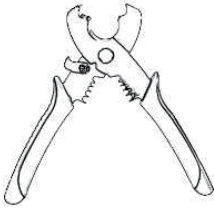

#1



#2



#3

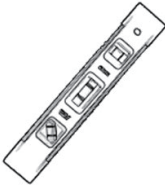

#4



#5

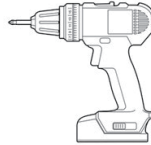

#6

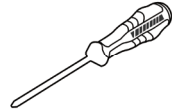

#7

Note: The above tools are very important, please gather them all.

5. Plan The Mounting

⚠ WARNING:

In areas with frequent thunderstorms, add surge protection at the service panel for all circuits. Ensure all power and ground connections, especially those at the breaker and bus bar, are clean and tight.

⚠ CAUTION:

Not recommended to be installed in coastal environments with high humidity or high dust.

USER MANUAL

STEP 1

Select the appropriate mounting location with electrical capacity:

- I. Ensure the owner has chosen a mounting location that allows the charging cable to reach the car's charging port while still providing slack.
- II. The device must be anchored into mounting such as 80mm x 130mm stud or a solid wall.
- III. The device shall be mounted at height between 600 mm and 1200 mm from ground.

STEP 2

Built-in hole position diagram. Just punch holes according to the picture.

Drill two screw holes with a diameter of 12mm and a depth of 57mm on the mounting wall. The width distance between the two holes is 100mm.

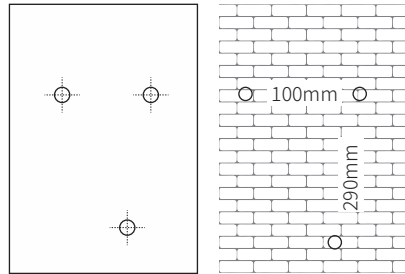

Mounting hole bitmap

5.1 Mount the charger

STEP 1

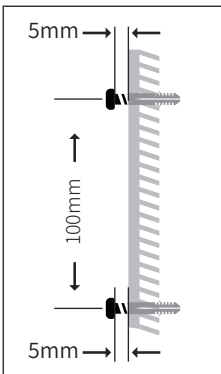

Top view

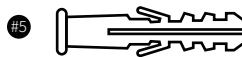

Nail #5 two expansion rubber sleeves into the holes and nail #3 two screw to the top expansion rubber sleeves. The distance of cover of screw and wall is about 5mm.

STEP 2

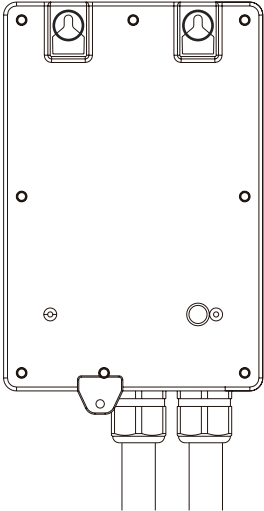

Align the rear notch of charger with the holes and hang the top notch on the top screw

Install a #3 screw at the bottom of the device when it is stable

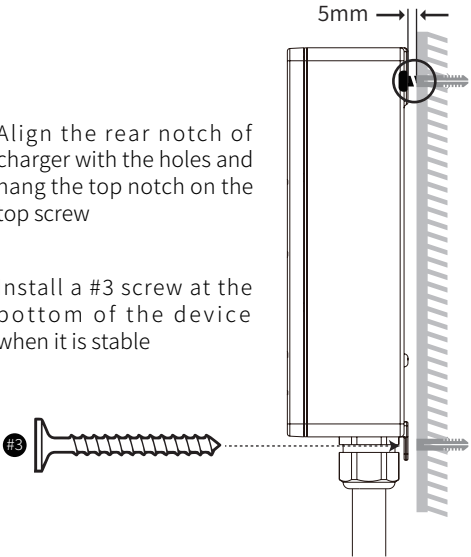

STEP 3

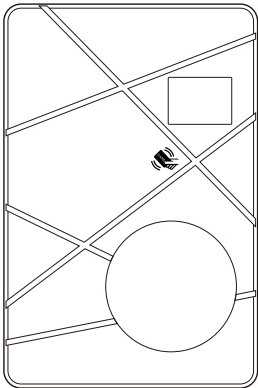
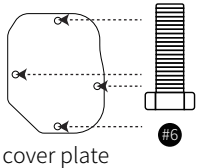
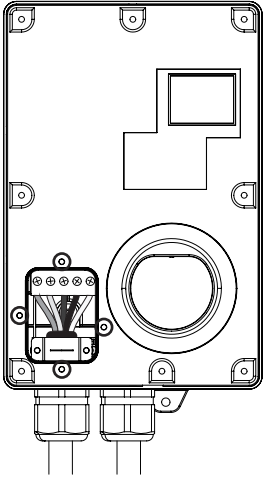

After the cover plate is placed in the corresponding position, install four #6 screws to the hole, and finally cover the face cover.

6. Wire The Circuit

⚠ WARNING:
This device must be grounded. Disconnect electrical power prior to installing the charging station.

⚠ WARNING:
Improper connection of the equipment-grounding conductor would result in a risk of electric shock. Check with a qualified electrician or serviceman if you are not sure whether the product is properly grounded. Do not modify the plug provided with the product if it doesn't fit the outlet, have a proper outlet installed by a qualified electrician.

⚠ CAUTION:
Use appropriate protection when connecting to the main power distribution cable.

STEP 6

For the safety purpose, please set circuit breaker protection in the input part of EV Charger.
Please follow the instructions below:

For Single Phase

Connect the L1 lead to the grid L1, connect the N lead to the grid N, connect the PE lead to the grid PE.

For Three Phase

Connect the L1 lead to the grid L1, connect the L2 lead to the grid L2, connect the L3 to the grid L3, connect the N lead to the grid N, connect the PE lead to the grid PE.

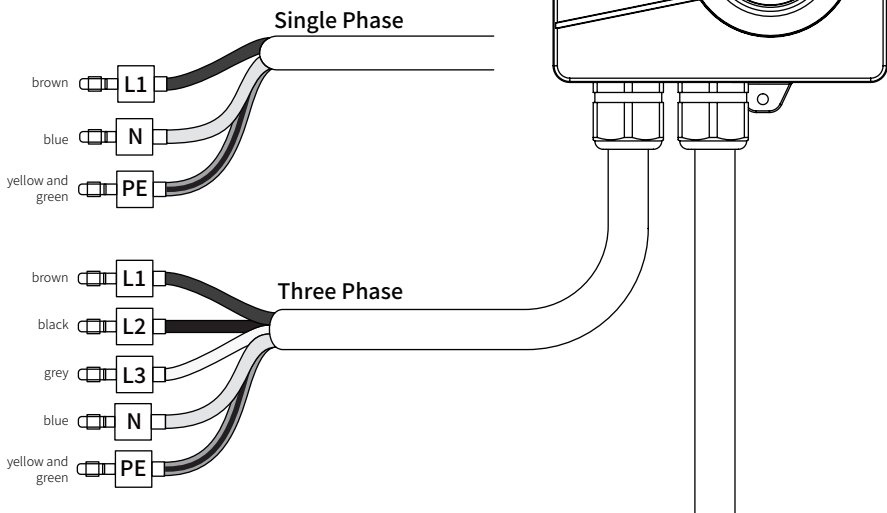

Three Phase

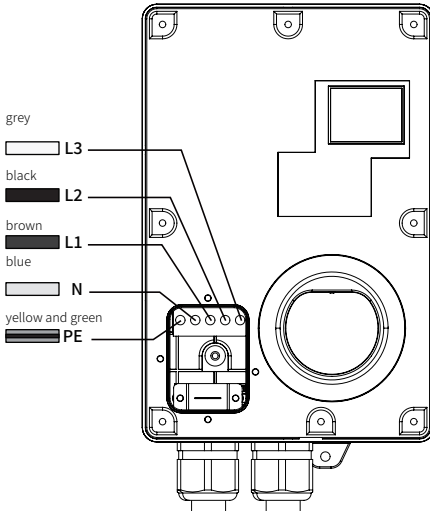

Single Phase

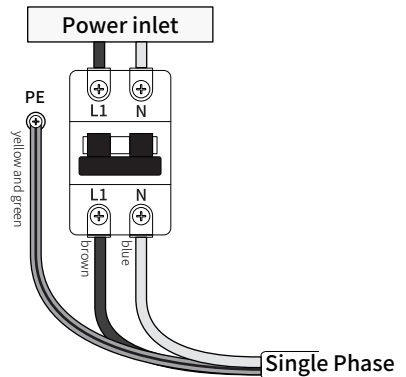
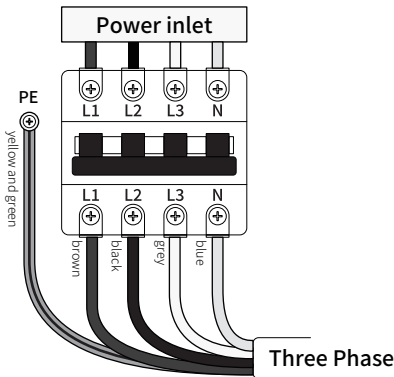
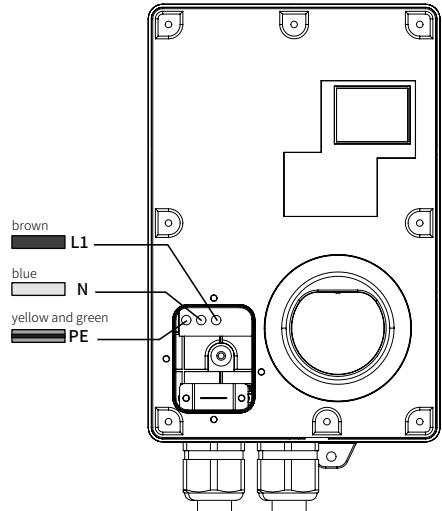

It is recommended that the neutral wire pass through the switch

Three Phase

Connect the L1 lead to the grid L1, connect the L2 lead to the grid L2, connect the L3 to the grid L3, connect the N lead to the grid N, connect the PE lead to the grid PE.

Single Phase

Connect the L1 lead to the grid L1, connect the N lead to the grid N, connect the PE lead to the grid PE.

Circuit Breaker Options		
	3 Phase	
Output Amperage (A)	16A	32A
Circuit Breaker Options (A)	20A	40A

Circuit Breaker Options table	
	1 Phase
Output Amperage (A)	32A
Circuit Breaker Options (A)	40A

7. Operate the Device

-
- ⚠ WARNING:**
This device should be supervised when used around children.

 - ⚠ CAUTION:**
Please use the charger properly. Do not hit or press hard on the enclosure. If the case is damaged, please contact a professional technician.

 - ⚠ CAUTION:**
Do not put heavy objects on the charger to avoid danger.
-

7.1 Operating Steps with Plug and Charge

STEP 1

Standby:

After the power has been turned on, you will see the sign “Please swipe your card or scan the code to start charging” on the LED screen.

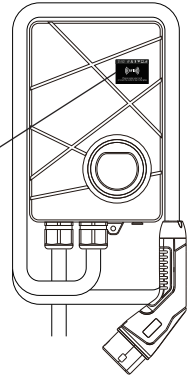
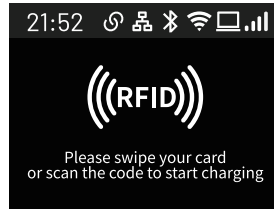

STEP 2

Plug the Charging Connector:

Please plug the charging connector into the vehicle charging inlet.

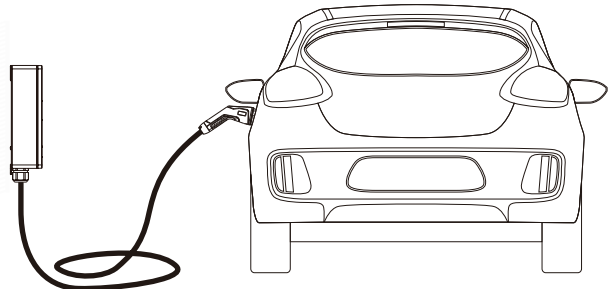

STEP 3

Charging:

When charging starts, the LED screen will display the following information

- Charging time
- Charging current
- Charging power

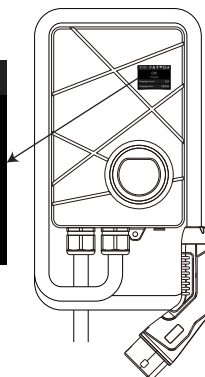
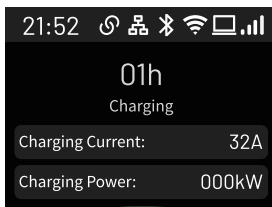

An error is reported:

if the sign “” is on, try to plug the vehicle connector again.

if the sign “” continues to be on, please refer to “9.Error and Warning Messages”.

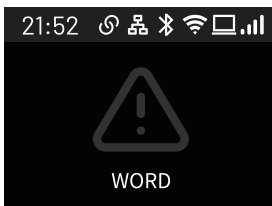

STEP 4

Charging finished:

After the charging is completed, the display screen of the charging pile will display the total charging time and the total charging amount

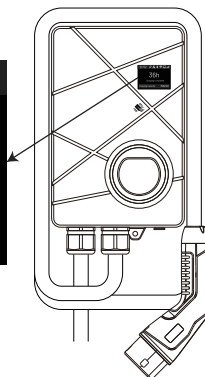
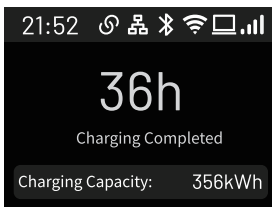

7.2 Operating Steps with RFID

⚠ CAUTION:
Please keep your RFID card properly to avoid unnecessary loss.

STEP 1

Standby:

After the power has been turned on, you will see the sign “Please swipe your card or scan the code to start charging” on the LED screen.

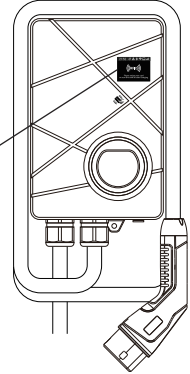
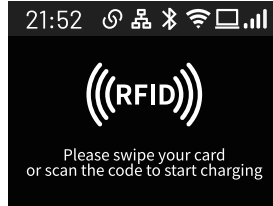

STEP 2

Plug the Charging Connector:

Please plug the charging connector into the vehicle charging inlet.

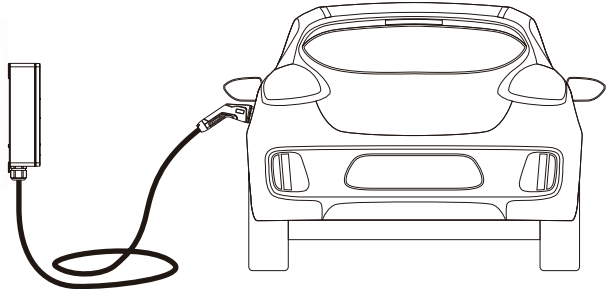

STEP 3

Swipe the standard RFID Card:

Hold the RFID card and touch the card area to start charging

You need to add your card to the APP before you can use it.

Refer to the 8.4 Menu Bar

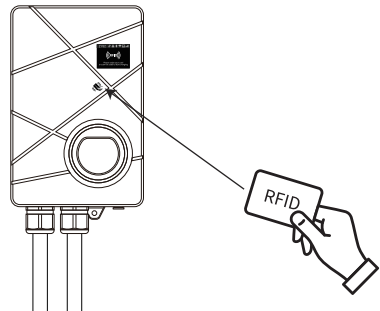

STEP 4

Charging:

When charging starts, the LED screen will display the following information

Charging time

Charging current

Charging power

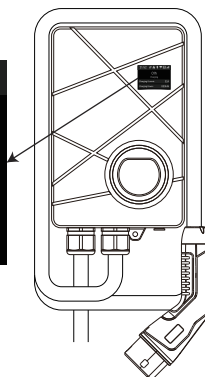
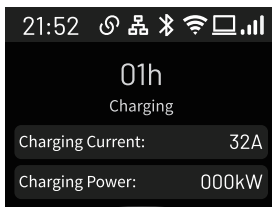

An error is reported:

if the sign “

if the sign “

21:52 [Icons: Refresh, Settings, Bluetooth, Wi-Fi, Signal, Battery]



WORD

STEP 5

Charging finished:

After the charging is completed, the display screen of the charging pile will display the total charging time and the total charging amount

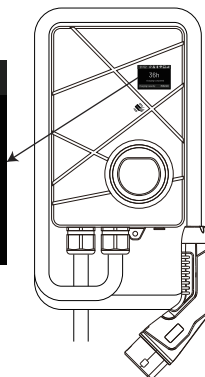
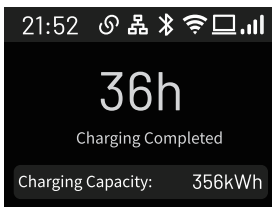

8. APP Operation Guide

1.1 APP Download Method

Search for “ChargeMAX” in the following app stores to download and install, or scan the code directly to jump to the download window and click to download.



1.2 Login or Register

A registration is required for the first use of the APP or you can log in quickly with Google and Apple ID.

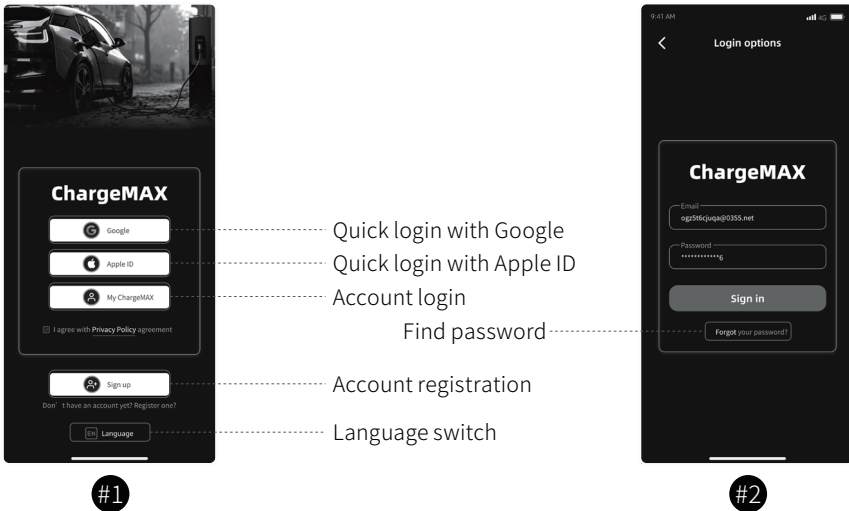

If you have an account but forget the password, you can retrieve it through #2.

8.1 Connect the device to start charging

1.1 Connect

When connecting the device for the first time, it is necessary to enable the Bluetooth function of the mobile phone. If you need to configure the network for the device, then you need to enable the WiFi function of the mobile phone.

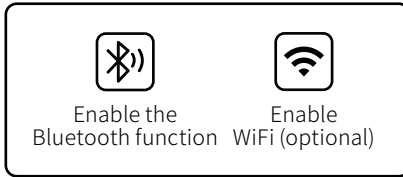

Quickly connect via the QR code on the side of the device.

Search for surrounding devices via Bluetooth and connect the device.

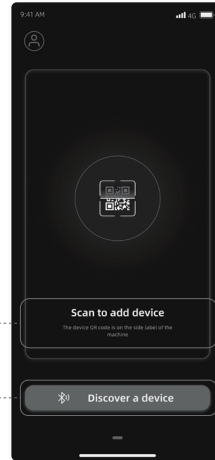

Device add page

When connecting the device, the mobile phone needs to be close to the device. A long distance may result in failure to connect the device, or connection timeout, and other faults.

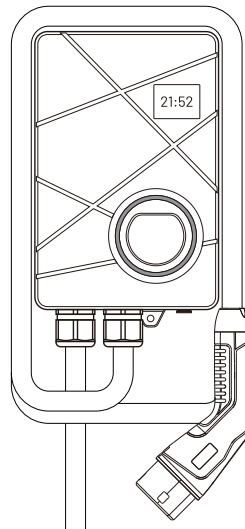
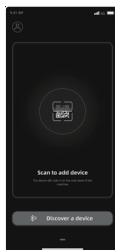

If you cannot find the surrounding devices via Bluetooth or fail to connect your device during the process of scanning the code to connect, please click “Help” to troubleshoot the faults.



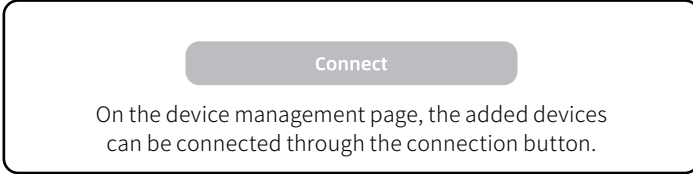

8.2 Device management page

1.1 Main Function

The page can be switched by sliding left or right, such as the device adding page or the device management page.





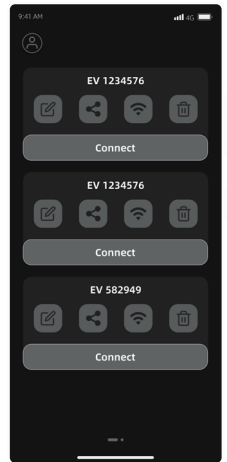

Admin device management page

-  Edit your device name.
The sharer synchronizes your device name and has no permission to edit.
-  Share your device.
The sharing function can be enabled or disabled with one click, or a certain user can be disabled.
-  In the black state, the device is connected via Bluetooth. After clicking, the state turns green and the device is connected via WiFi. If the device is not configured with WiFi, it is an unavailable state.
-  Delete your device.
After deletion, the first user who binds the device is the administrator.



Device Management Page

The page of the shared person

-  The shared person cannot edit the device name
-  Click to switch the connection mode
-  Check the administrator
-  Deleting the device
After deletion, you need to obtain the device share code from the administrator.

8.3 Charging Interface

1.1 Interface Functions

The device can only automatically perform scheduled tasks if the device is not faulty and is connected to your electric vehicle (plug and charge function needs to be turned off).

! If the plug-and-charge function is enabled, the planned charging cannot be started, and the plan cannot take effect when the device is already charged.

Back to device list

Menu

Charging time

Charging power

Plug and charge switch

Wi-Fi & Bluetooth

Current regulation
The charging current cannot be adjusted after the start of charging, and can only be adjusted after suspension.

Start Now

Start Plan
charging plans can be created with the Start Schedule button.

Standby interface

Charging interface

Failure cause

Failure solution
If you encounter a failure that cannot be solved, please contact customer service.

Device failure interface

8.4 Menu

1.1 RFID Card Addition

After entering the menu, click RFID Card to jump to the RFID Card addition interface. Click the + sign on the top right, and enter your RFID Card number in the pop-up input box (the card number is on the back of the RFID Card). After inputting, click Sure to start the device through the RFID Card.

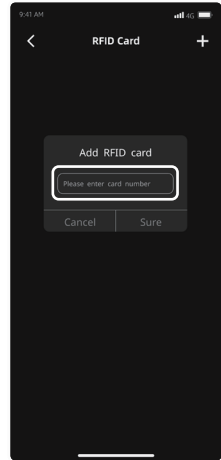
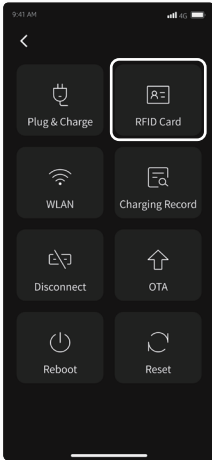

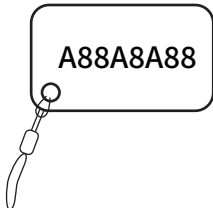

#3 RFID Card

Start your device by swiping your card as described in 7.2 Operating Steps with RFID

1.2 Local Query of Charging Records

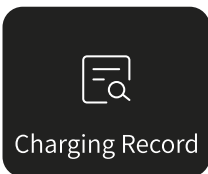

By connecting the device via Bluetooth, you can query the charging record of the device in the Charging Record in the menu bar. If your device is equipped with a network, you can query the charging record in the account on the device management page.

9. Error and Warning Messages

State	Screen Display	Remark
Off Ground	0001	Auto Recover
RCD Abnormal	0002	Auto Recover
Over Current Protection	0004	Auto Recover
Over Voltage Protection	0008	Auto Recover
Under Voltage Protection	0016	Auto Recover
Energy Meter Fault	0032	Contact Customer Service
Control Pilot Fault	0128	Auto Recover
Over Temperature Protection	0256	Auto Recover
Ground Fault	0512	Auto Recover
Ground Self-Test	1024	Auto Recover
Emergency stop failure	0064	Turn the emergency stop switch clockwise

10. Warranty and Maintenance

- The warranty period for this charger is one year.
- During the warranty period for any malfunction under normal use according to the User Manual and Service Instructions (to be determined by certified maintenance technicians of sellers), the product shall be repaired free of charge. Except for the following situations, the charger shall be subject to the above warranty terms:

1. The warranty certificate cannot be provided or the contents of the warranty certificate are modified or inconsistent with the label indication of the repaired product.
2. Those who are unable to provide valid proof of purchase.
3. Those who exceed the manufacturer's specified warranty period.
4. Those who damage the product due to not following the product service instruction for use, maintenance and storage.
5. Damage or malfunction caused by external object entering.
6. Unauthorized repair, disassembly or modification.
7. Damage caused by force majeure (such as lightning, excessive voltage, earthquake, fire, flood, etc.).
8. Malfunction and damage caused by other unavoidable external factors. Malfunction and damage caused by improper use of equipment, such as water or other solutions entering into the equipment.
9. Malfunction and damage caused by the grid power supply and voltage which is not specified for use with the charger equipment.

The above guarantees shall be made solely, and no other express or implied warranties shall be made (including the implied warranties of merchant ability, particular and applicable reasonableness and adaptability, etc.) whether in the contract, civil negligence, or other aspects, the Company shall not be responsible for any special, incidental or consequential damages.

